

WINDOWS DISTINCTION

HIGH SECURITY REPLACEMENT WINDOWS DOORS & CONSERVATORIES

Unit 2 Broadmeadow Industrial Estate, Teignmouth, TQ14 9AE.

Tel 01626 772313.

Fax 01626 879837

BERECO
INSPIRED

 Bereco

DELIVERING THE DIFFERENCE.

WE MAKE BESPOKE, HIGH QUALITY, HIGH PERFORMANCE TIMBER WINDOWS & DOORS TO SUIT ANY STYLE OF PROPERTY.

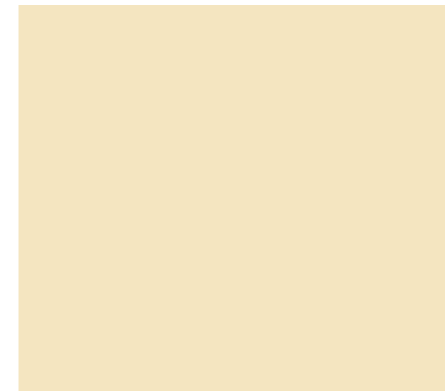

ENVIRONMENTAL CARE

We are committed to using environmentally friendly practices throughout the manufacturing process. All products are made using FSC® certified timber, sourced from well managed forests.



QUALITY & PERFORMANCE

We use only the finest paint system, timber, hinges and ironmongery. High performance, high security and enhanced weather features mean our windows and doors will perform for years to come.



FRIENDLY & PROFESSIONAL

Our emphasis is on providing a professional and friendly service from concept to completion. Our knowledgeable staff offer design inspiration, technical support, itemised quotations and CAD drawings.

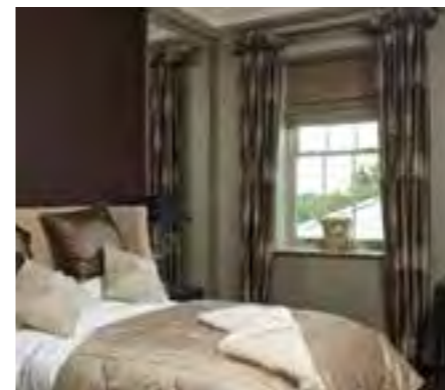

CHOICE & FLEXIBILITY

Our product ranges are carefully designed to include a wide selection of bespoke window and door types. Various designs, finishes and matching ironmongery can be supplied with specialist glazing.

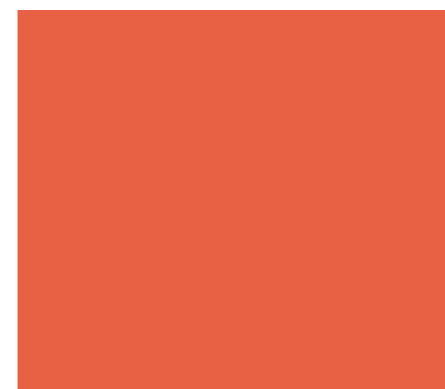

Winner of Daily Telegraph
Homebuilding & Renovating
UK Traditional House Award



SASH

Vertically opening Sliding Sash Windows have been a feature of British buildings dating as far back as the Georgian, Victorian and Edwardian periods and still prove ever popular in today's modern homes.

Bereco Sliding Sash Windows have been designed to include traditional features, whilst incorporating modern operation, technology and energy efficiency.

Available in semi concealed spiral balance or cords & weights styles, products are internally glazed, featuring double weatherstrips and cutting edge glazing options. Tested to the highest performance, security and weather rating standards, Bereco Sliding Sash Windows are the ultimate choice for both prestigious new build or replacement situations.

Contemporary Range sash windows offer minimalist lines utilising pencil round mouldings, contemporary horn detail and 24mm double glazed, Argon filled units as standard. Triple glazing can also be incorporated to further increase the overall performance of the window.

Bereco's Traditional Range sash windows offer all the benefits of the Contemporary Range but give added aesthetic value with the use of ovolo and putty bead mouldings and a decorative horn detail.

Heritage Range sash windows complete the Bereco portfolio with a choice of either 4mm single or 14mm SlimLine double glazing. Lambs tongue and putty bead mouldings, a decorative horn detail, slim frame sections and a market leading back to front frame depth of only 140mm make the Heritage sash windows ideal for listed buildings and where conservation approval is necessary.



Images show Traditional Range Sliding Sash Spiral Balance Windows with 16mm lambs tongue Georgian bar design and bespoke feature fanlight with sunburst detail. Finish is RAL 9016 Traffic White.



Safe & Secure

BERECO SLIDING SASH WINDOWS ARE SUPPLIED WITH KEY OPERATED VENT LOCKS OR PUSH BUTTON ANGEL VENTLOCKS TO RESTRICT SASH OPENINGS FOR CHILD SAFETY.



ANGEL VENTLOCK™
Window safety for our children

Image shows Contemporary Range Sliding Sash Spiral Balance Windows with vent lock and 16mm Georgian bar design. Finish is RAL 9001 Cream.



Enhance the
opulence
& grandeur
of prestigious
buildings.

Image shows Traditional Range
Sliding Sash Spiral Balance Windows.



Maximise indoor & outdoor living space.

Image shows Traditional Range Sliding Sash Spiral Balance Windows with 16mm lambs tongue Georgian bar design. Traditional Range Patio Doors and French Doors. Finish is RAL 9016 Traffic White.



**A subtle mixture
of old & new.**

Image shows Contemporary Range Sliding Sash Cords & Weights Windows. Finish is RAL 9016 Traffic White.

The Coast is Clear

Bereco supplied Sliding Sash Windows and Lipped French Doors from the Traditional Range for a coastal holiday retreat.



BERECO CAN DESIGN BESPOKE WINDOWS AND DOORS TO SUIT A WIDE RANGE OF COMMERCIAL PROPERTIES INCLUDING HOTELS, RESTAURANTS AND OFFICE SPACES TO MEET SPECIFIC REQUIREMENTS.

Image shows Traditional Range Sliding Sash Spiral Balance Windows and Lipped French Doors. Finish is RAL 9016 Traffic White.

GLENTRUIM CASTLE

The truly stunning Category B listed Glentruim Castle is situated near to the rivers Spey & Truim close to the village of Newtonmore in Inverness-shire, Scotland. Located at the gateway of Cairngorms, Britain's largest national park, the surrounding breath-taking scenery can be seen from all aspects of the castle.

Dating back to the early 1840's, the castle was originally built by Major Euan Macpherson and today is a privately owned holiday retreat, offering luxury self-catering accommodation.

The beauty and grandeur of the castle makes a striking impact on the surrounding landscape so any renovation works had to be sympathetic to its character.

A W Carpentry Services Ltd worked with the client on the replacement of the original timber windows and doors during the recent refurbishment of the castle.



“ I am delighted by both the quality and the appearance of the Heritage Range windows supplied by Bereco. They further enhance the appearance of Glentruim Castle and from an environmental and economical point of view the addition of SlimLine double glazing will most certainly save energy and reduce our heating bills each year. ”

DEIRDRE FALCONER, ESTATE MANAGER, GLENTRUIM CASTLE

TOP IMAGE shows Heritage Range Sliding Sash Cords & Weights Windows with 25mm Georgian bar design and 14mm SlimLine double glazing. Finish is RAL 9016 Traffic White.

BOTTOM IMAGE shows Traditional Range Folding Doors with 25mm Georgian bar design. Finish is RAL 9016 Traffic White.



MAIN IMAGE & RIGHT TOP IMAGE shows Heritage Range Sliding Sash Cords & Weights Windows with 25mm lambs tongue Georgian bar design. Finish is RAL 9016 Traffic White.

BOTTOM RIGHT IMAGES show Heritage Range Sliding Sash Cords & Weights Windows with 25mm lambs tongue Georgian bar design. Finish is dual colour with Walnut 5064 Stain interior and RAL 9016 Traffic White exterior.



Some windows featured are **dual colour** to suit the interior decor.



An energy survey of the castle concluded that **significant heat was being lost through the old single glazed timber windows.**

Bereco had previously supplied windows for the walled garden cabin on the Glentruim Estate and Deirdre, the Estate Manager, had been impressed with the result. The Heritage Range offered the ideal solution to complement the historic appearance of the castle whilst offering 21st century performance.



The SlimLine double glazed units offer low U values to improve energy efficiency whilst retaining the appearance of traditional single glazed windows.

The experienced design technicians at Bereco were able to offer assistance with U value calculations and designed bespoke products to meet the specific requirements of the project.



01.



02.



03.

THE CASTLE FEATURES A MIXTURE OF BESPOKE PRODUCTS, FROM SLIDING SASH CORDS & WEIGHTS DESIGNS TO LARGE SPANNING FOLDING DOORS. ALL HAVE BEEN SUPPLIED WITH MATCHING PROFILES AND SLIM 25MM GLAZING BARS WHICH WERE A SPECIFIC REQUIREMENT OF HISTORIC SCOTLAND.

Impressively, the total refurbishment of the castle took just 1 year from start to finish.

As with all listed buildings, great care had to be taken. Every aspect of the refurbishment had to comply with the strict conservation requirements of Historic Scotland.

It was an essential requirement that the aesthetics of the replacements were closely matched to the original single glazed windows.

Approval was gained for the existing single glazing to be replaced by our SlimLine double glazed units to improve the U values, making them more thermally efficient.

- 01. Image shows Sliding Sash polished brass pulley wheels.
- 02. Image shows Traditional & Heritage Range Sliding Sash Window external horn detail.
- 03. Image shows the Heritage Range Sash Lock.



Image shows Heritage Range Flush French Doors with 25mm Georgian bar design and raised & fielded panels. Finish is RAL 9016 Traffic White.

A bespoke marginal bar design.

Images show Traditional Range Sliding Sash Cords & Weights Windows with 25mm marginal bar design. Finish is RAL 9016 Traffic White.

Traditional Range Flush French Doors with sidelights. Finish is RAL 9016 Traffic White.



create your **dream home**

beautifully bespoke

Image shows Contemporary Range Sliding Sash Cords & Weights Windows and Tilt & Turn Sliding Sash look-alike windows with 60mm solid bar and 16mm vertical bar design. Window features plant on horns.

Single leaf Lipped French Door with curved head & fixed glazing screens. Finish is RAL 1015 Light Ivory.

FEATURE: This property features curved on plan cills and head drip to accentuate the curve of the building.



FOR FIRE ESCAPE,
TILT & TURN
WINDOWS CAN BE
DESIGNED TO GIVE
THE APPEARANCE
OF A SLIDING SASH.





Image shows Contemporary Range Sliding Sash Cords & Weights Windows with a 16mm Georgian bar design. Finish is RAL 9016 Traffic White.



Image shows Traditional Range Sliding Sash Spiral Balance & Traditional Flush Casement Windows with 35mm Georgian bar design and curved head. Finish is RAL 9016 Traffic White.

FULHAM BOYS SCHOOL

The Fulham Boys School, located in London, is a Church of England Secondary School for boys which re-opened in September 2014.

Traditional style replacement timber windows were required throughout the school and Sash Windows London were invited to work alongside WS Builders to undertake this challenging window installation of over 130 replacements within a strict timescale.

It was essential that the replacement windows were designed to match the existing timber products in the building as closely as possible to meet the approval of the London Borough of Hammersmith and Fulham.

The Traditional Range was the ideal choice as the windows had to combine period aesthetics to complement the building with high performance features to ensure a suitable school environment for over 500 pupils.

THE PROJECT
FEATURES BESPOKE
GEORGIAN STYLE
TIMBER SLIDING
SASH WINDOWS
WEIGHING ALMOST
200 KILOGRAMS!



Images show Traditional Range Sliding Sash Spiral Balance and Flush Casement Windows with 35mm Georgian bar design and curved head.



“ We chose Bereco to supply the windows for this project as we know that the product quality and lead times are consistent which was imperative to this project. ”

FRANCESCA COLEMAN-CARR,
SASH WINDOWS LONDON

A variety of bespoke timber windows with a Georgian bar design have been installed throughout the building. Products include large Sliding Sash Windows in spiral balance design with opening fanlights and Flush Casements with a curved head design.

The windows are fully factory finished with extensive warranties and offer low U values providing excellent energy performance.

With a consistent lead time all year round, Sash Windows London could rely on Bereco to supply the windows in time to meet the project deadline.

AS A RESULT OF THE HIGH QUALITY WINDOWS AND INSTALLATION WORK CARRIED OUT ON FULHAM BOYS SCHOOL, SASH WINDOWS LONDON HAVE NOW BEEN INVITED TO QUOTE FOR FULHAM GIRLS SCHOOL.



Entertain in style.

Image shows Traditional Range Flush Casement Windows with 25mm cottage bar design. Finish is RAL 9016 Traffic White. Windows feature polished chrome handles and casement stays.

CASEMENT

Bereco Casement Windows can be supplied with either a top hung or a side hung method of operation and are available in lipped or flush designs.

Casements offer excellent weather ratings and a high security espagnolette locking system with friction hinges as standard. Casements are available in contemporary, traditional and heritage profiles.

The Contemporary Lipped Casement with its stormproof design and sleek pencil round mouldings is typical of a 20th century window, perfect for any new build home. In contrast, for a period look, the Traditional Lipped Casement features distinctive traditional ovolo mouldings casement stays and night vents, exclusive to the range.

Flush Casements, available from the Traditional and Heritage Ranges, have a classic flush appearance, traditional mouldings & dummy butt hinges to replicate all the features of a period window.

The heritage profile, with the option of 4mm single or 14mm SlimLine double glazing is suitable for listed properties or those governed by the demands of conservation.



Designed to suit any angle, bow bay windows can be supplied with varying frame widths and curved cills.

Bespoke fanlight with curved lead.

Image shows Traditional Range Flush Casement Windows with curved fanlight and faceted bay with curved cill. Finish is RAL 9016 Traffic White. Window features satin chrome Bulb End handles, casement stays and silver lead.



Choose a contrasting window & door finish.

Image shows Contemporary Range Lipped Casement Windows. Finish is RAL 7024 Graphite Grey. Entrance Door in contemporary profile with 60mm solid cottage bar design. Finish is RAL 9016 Traffic White.

Modern styling & operation.

Image shows Contemporary Range Lipped Casement Windows and Lipped French Doors with 16mm cottage bar design. Finish is RAL 9016 Traffic White.



Image shows Traditional Range Lipped Casement Windows with 9mm antique black lead. First and second floor windows feature a solid bar to recreate a fanlight design. Finish is RAL 9016 Traffic White.

Entrance Door in traditional profile with sidelights. Finish is dual colour with RAL 9016 Traffic White frame and RAL 9005 Jet Black leaf.



THRUM MILL

Featured on
Channel 4's
Restoration Man

Margaret and Dave Hedley bought the Grade II listed Thrum Mill in Rothbury, Northumberland five and a half years ago. For two years the couple worked alongside Channel 4's Restoration Man programme that tracked the mill's gradual transformation. The project has been a true labour of love for the Hedleys as they project managed and completed much of the renovation work themselves.

TRADITIONAL WINDOW
PROFILES COMBINED WITH
MODERN PERFORMANCE NOT
ONLY RETAINS THE PROPERTY'S
PERIOD AESTHETICS BUT
EXCEEDS THE GOVERNMENT'S
STRINGENT THERMAL AND
WEATHER REGULATIONS.

Image shows Traditional
Range Flush Casement
Windows with a 16mm lambs
tongue Georgian bar design.
Finish is BS.10.B.17 Oatmeal.



“ We were delighted with the windows, they look fantastic and everyone at Bereco has been so helpful. We were reassured by their experience and knowledge of Grade II planning restrictions. ”

MARGARET HEDLEY, OWNER, THRUM MILL



Retain period features whilst improving your comfort.

Bereco's conservation approved Flush Casement timber windows from the Traditional Range with Georgian bar design were the perfect choice.

The noise of the river can be quite loud when in full flow and Restoration Man presenter, architect George Clark was fascinated by the effective sound proofing properties the bespoke wooden windows provide.

The Grade II listed building had 29 restrictions in total and strict conservation requirements meant replacing the existing windows presented a huge challenge.

Margaret was keen to ensure as much natural light entered the property as possible whilst framing the picturesque view of the river.

Images show Traditional Range Flush Casement Windows with a 16mm lambs tongue Georgian bar design. Finish is BS.10.B.17 Oatmeal. Windows feature black Monkey Tail handles.



“ Bereco offer a really nicely engineered and constructed solution. ”
HUGH MASSEY, HUGH MASSEY ARCHITECTS

A CLASSIC FLUSH
LINE APPEARANCE
AND DECORATIVE
BUTT HINGES
REPLICATE
PERIOD FEATURES.



Images show Heritage Range Flush Casement Windows and bespoke bay with 16mm lambs tongue Georgian bar design and 14mm SlimLine double glazing. Finish is NCS S-0105-Y10R White.

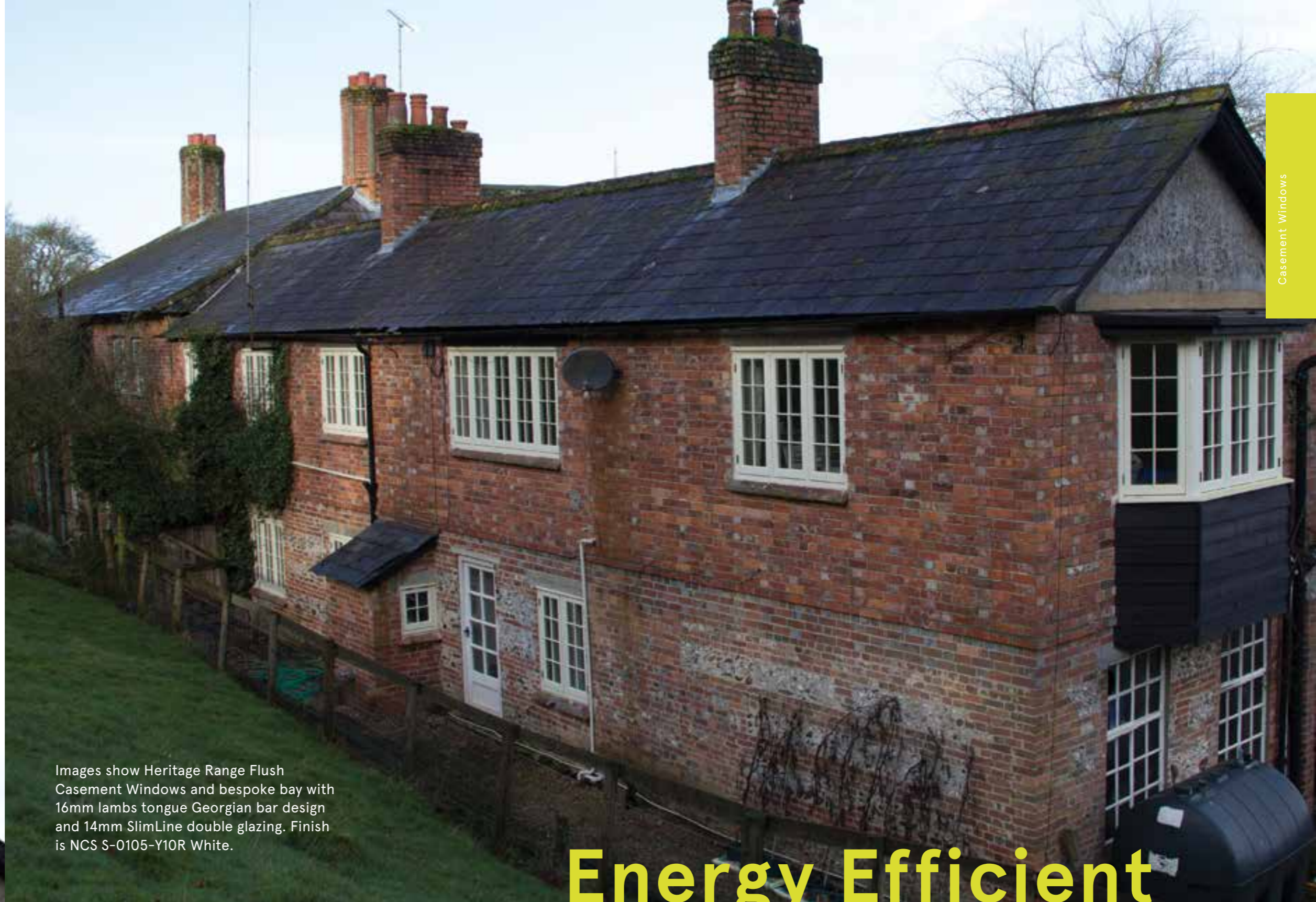

Energy Efficient Period Living

A BAY WINDOW CAN
BE PRE-MADE TO ANY
ANGLE OR SUPPLIED AS
INDIVIDUAL UNITS FOR
ON SITE ASSEMBLY.





A variety of bespoke bar designs are available across the Bereco range.

“ I have been very impressed by Bereco windows, they are without doubt the best I have seen. I was a bench hand joiner many years ago and would never imagine a finish to be achieved like this from a timber product, they are fantastic. Thanks very much for the professional way in which you dealt with the whole process, it is much appreciated. ”

Neil Butterworth
Fairway Construction

Image shows Traditional Range Flush Casement Windows with bespoke 25mm Victorian bar design. Entrance Door in a traditional profile with sidelights. Finish is RAL 9016 Traffic White.



Image shows Traditional Range Flush Casement Windows with 25mm cottage bar. Finish is RAL 9016 Traffic White. Windows feature polished chrome ironmongery.

01709 838188



01.



02.

Flying mullions can be used for fire escape.

- 01. EGRESS FRICTION HINGE
Available on Lipped and Flush Casements
- 02. GU CONCEALED HINGE
Available on Flush Casements only



Fixed Sash & Fixed Light.

Fixed sashes give the appearance of an opening sash to create equal sight lines across the window whilst fixed lights maximise glazing areas.

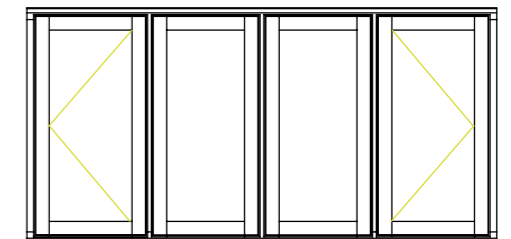

Fixed Sash.

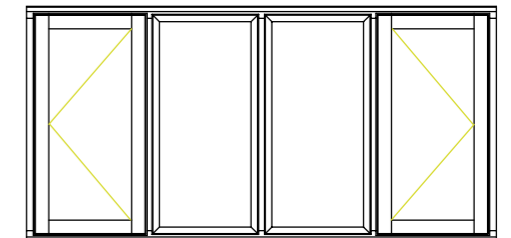

Fixed Light.



40dB
Acoustic glazing was used due to the city centre location.

TILT

Tilt & Turn Windows are one of the most versatile designs used in the market today.

The design flexibility offered by this product with large sashes often means they are used in atriums, orangeries, screens and large glazed areas.

The inward opening windows enable easy cleaning, whilst the tilt mechanism provides ventilation without intruding on internal room space. A Sliding Sash look-alike option with plant on horns is commonly used when other window styles cannot meet fire escape regulations.

The concealed hinge system and customised timber plant on over drainage channels further enhance the products appearance.

Use of double weatherstrips and high security locking systems ensure optimal weather and security performance.

Tilt in, turn in and tilt & turn in window and door options are available in contemporary or traditional profiles with double or triple glazing.

◀ Radisson Blu Hotel

Bereco supplied 16 sets of bespoke Tilt & Turn Doors with fanlights from the Traditional Range for the Radisson Blu Edwardian Sussex Hotel in London. Finish is RAL 9016 Traffic White.



Image shows Contemporary Range fixed angled head Tilt & Turn Screen, opening in Folding Sliding Doors and Tilt & Turn Doors.

BERECO TILT & TURN WINDOWS FEATURE A FULLY FACTORY FINISHED TIMBER PLANT ON TO CONCEAL THE UNSIGHTLY ALUMINIUM DRAINAGE CHANNEL, A DESIGN WHICH IS UNIQUE TO BERECO.

Make a point

with a bespoke angled head screen.



Image shows Contemporary Range Tilt & Turn Windows. Finish is 5056 Afromosia Stain.



Image shows Contemporary Range Tilt & Turn Windows, Screens and Patio Doors. Finish is RAL 7016 Anthracite Grey.



Images show Contemporary Range Tilt & Turn Windows with angled head feature and large glazing screens. Entrance Door in contemporary profile and Lipped French Doors. Finish is 5052 Oak stain.



Image Shows Contemporary Range
Tilt & Turn Windows and Lipped French
Doors. Finish is 5059 Cherry stain.





Image shows Entrance Doors in contemporary profile with sidelights and fanlights. Finish is dual colour with RAL 5013 Cobalt Blue leaf and RAL 9016 Traffic White frame. Contemporary Range Lipped Casement Windows with 16mm double horizontal bar design. Finish is RAL 9016 Traffic White.

ENTER

Design a truly unique entrance with a completely bespoke Entrance Door, supplied pre-hung ready for installation.

Hand-pick from a wide variety of designs that can be used to create any style of door with the option of a contemporary or traditional profile.

The finest high performance components, secure locking systems, laminated glazing and 3D adjustable hinges are supplied as standard.

All Entrance Doors are constructed to be thermally efficient with a 68mm door leaf, 92mm deep frame and insulated panels. A double weatherstrip around both the door leaf and frame ensures tight seals for excellent weather performance.

Entrance Doors are certified to the latest PAS 24:2012 standards with high security features to meet Secured by Design requirements.

**SINGLE LEAF ENTRANCE DOORS
CAN BE SUPPLIED WITH WIDTHS UP
TO 1250MM & HEIGHTS UP TO 2600MM***

*Sizes may vary depending on width and height combination.

CURVED HEAD

Image shows Entrance Door in traditional profile with curved head. Finish is dual colour with RAL 9010 Pure White frame and RAL 5024 Pastel Blue leaf. Door features an antique black handle and letterplate.



To continue the curve of the door, a Traditional Range Flush Casement Window with curved head and 16mm horizontal bar design was supplied. Finish is RAL 9010 Pure White.



SUNBURST FANLIGHT

Image shows Entrance Door in traditional profile and deep mid-rail. Door features panelled sidelight, curved fanlight and bespoke 16mm sunburst bar design. Finish is RAL 9016 Traffic White.

BERECO ARE A FULLY LICENSED MEMBER OF SECURED BY DESIGN, A NATIONAL POLICE INITIATIVE DESIGNED TO REDUCE AND PREVENT CRIMES IN HOMES ACROSS THE COUNTRY.

Secured by Design



Official Police Security Initiative

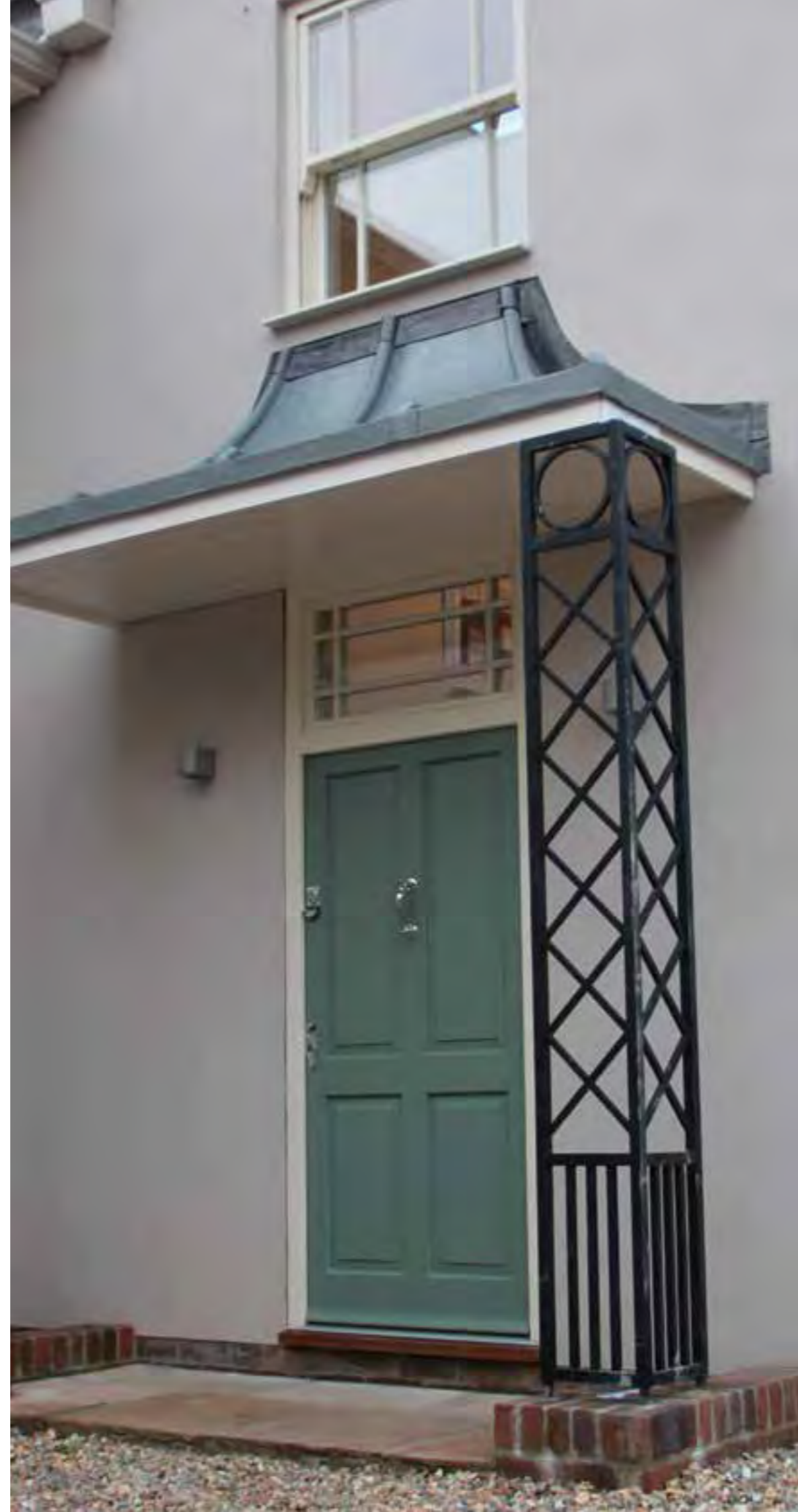

LEFT image shows Entrance Door in a traditional profile and fanlight with 25mm marginal bar pattern. Finish is dual colour with NCS-S-1005-Y20R Parlour frame and Farrow & Ball match Card Room Green 79 leaf. Door features polished chrome Doctors Door Knocker.

TOP RIGHT image shows Entrance Door in traditional profile with sidelights & fanlight. Finish is dual colour with RAL 9016 Traffic White frame and RAL 9005 Jet Black leaf. Traditional Range Sliding Sash Spiral Balance Windows with 16mm lambs tongue Georgian bar design.

BOTTOM RIGHT image shows Entrance Door in traditional profile with sidelights. Finish is RAL 9016 Traffic White.



Entrance Doors

www.bereco.co.uk



Adapt a Sliding Patio Door to create a unique entrance.



- 01. Image shows Contemporary Range Sliding Patio Door with 16mm double horizontal bar design and panel detail. Finish is RAL 7003 Moss Grey.
- 02. Image shows Entrance Door in contemporary profile with sidelights. Finish is dual colour with RAL 9016 Traffic White frame and 5052 Oak stain leaf.
- 03. Entrance Door in contemporary profile with mobility threshold. Finish is dual colour with RAL 9001 Cream frame and Farrow & Ball match Downpipe 26 leaf.
- 04. Entrance Door in traditional profile. Finish is RAL 9016 Traffic White.
- 05. Entrance Door in contemporary profile with 16mm personalised bar arrangement. Finish is RAL 9001 Cream.
- 06. Opening out Entrance Door in contemporary profile. Finish is dual colour with RAL 9001 Cream frame and Farrow & Ball match Pigeon 25 leaf.
- 07. Entrance Door in traditional profile. Finish is dual colour with RAL 9010 Pure White frame and RAL 1018 Zinc Yellow leaf.
- 08. Double leaf Entrance Door in traditional profile with gothic fanlight and 35mm bar in sunburst design. Finish is 5060 Pine stain.
- 09. Entrance Door in traditional profile with 25mm bar design. Finish is NCS-S-3010-G80Y French Green. Door features antique black handle and letter plate.



Featured on Channel Five's "I Own Britain's Best House."



Stable Doors.

Stable Doors are the ideal choice to create a traditional country cottage feel. They are often chosen for period property refurbishments and to retain the original charm and character of a farmhouse style building.

Image shows Stable Door in traditional profile with a 16mm cottage bar design. Finish is dual colour with RAL 9001 Cream frame & interior leaf and RAL 6013 Reed Green exterior leaf.

Traditional Flush Casement Windows with 16mm lambs tongue horizontal bar design. Finish is RAL 9001 Cream.



Image shows Entrance Door in traditional profile with silver lead. Finish is dual colour with RAL 9010 Pure White frame and Farrow & Ball match Stone Blue 86 leaf.



- 01 FRAME: Farrow & Ball match 2003 Pointing. LEAF: NCS-S-1085-Y90R Bright Red.
- 02 FRAME: Farrow & Ball match 2005 All White. LEAF: NCS-S-0560-Y Bright Yellow.
- 03 FRAME: NCS-S-1005-Y20R Parlour LEAF: NCS-S-6020-R80B Blue.
- 04 FRAME: NCS-S-1005-Y20R Parlour. LEAF: Farrow & Ball match 92 Castle Grey.
- 05 FRAME & LEAF: RAL 1015 Ivory

Create a period look with a wide range of bespoke features in a traditional profile.

All Bereco door designs are fully finished in a **colour of your choice.**



- 06 FRAME: Farrow & Ball match 2008 Dimity. LEAF: Farrow & Ball match 96 Rectory Red.
- 07 FRAME: Farrow & Ball match 2005 All White. LEAF: RAL 5010 Gentain Blue.
- 08 FRAME: RAL 9016 Traffic White. LEAF: RAL 9005 Jet Black.
- 09 FRAME & LEAF: NCS-S-4550-B30G Turquoise.
- 10 FRAME & LEAF: Walnut stain 5064

Make a statement.

Images show single leaf, key operated bespoke Entrance Door in traditional profile with fanlights and sidelights. Finish is dual colour with RAL 9016 Traffic White frame and interior and RAL 4007 Purple Violet leaf exterior.



CREATE

The Creative Range is a collection of ultra-modern door designs exclusively crafted using sharp lines and flush panels to create a minimalist appearance.

Creative Range Doors are certified to the latest PAS 24:2012 standards meeting Secured by Design requirements. Thermally insulated panels feature fibre glass reinforcements and aluminium stabilisation layers to ensure the highest level of security and performance.

Available in a choice of 3 veneer finishes; Redwood, Dark Red Meranti and Larch in a variety of paints, stains and dual colour options.

“Bereco were able to match the very specific contemporary door design we had in mind for this very unique property with an Entrance Door from the Creative Range.

The option of a dual colour finish enabled us to match the Entrance Door to the external materials of the property, in addition to the internal doors.”

Ben Lampert
Development Manager,
Hamilton Court Developments

Ultra sleek modern designs

Creative Entrance Doors



Image shows Creative Range Entrance Door with bespoke sidelight, frosted glazing and clear border. Finish is RAL 7015 Slate Grey.



Ud value of only
0.99 W/m²K

Ironmongery is for illustration purposes only, requirements can be specified on enquiry.

1 Veneer: Hardwood
Finish: Walnut stain 5064

2 Veneer: Redwood
Finish: RAL 7016 Anthracite Grey
Glass: Clear

3 Veneer: Hardwood
Finish: Light Pine stain 5063
Glass: Frosted

4 Veneer: Larch
Finish: Light Pine stain 5063

5 Veneer: Redwood
Finish: RAL 9016 Traffic White

6 Veneer: Redwood
Finish: RAL 7016 Anthracite Grey
Glass: Frosted

7 Veneer: Hardwood
Finish: Oak stain 5052
Glass: Frosted

8 Veneer: Redwood
Finish: Antique Pine stain 5062
Glass: Frosted

9 Veneer: Larch
Finish: Light Pine stain 5063
Glass: Frosted

10 Veneer: Hardwood
Finish: Oak stain 5052



Image shows Traditional Range Flush French Doors with 25mm cottage bar design. Finish is RAL 9016 Traffic White. Doors feature double Balmoral handle in polished chrome.

FRENCH

French Doors or French Windows, as they are sometimes known, can be supplied in single or double leaf configurations with a variety of sidelights, fanlights and panels within the doors, to suit the room design.

Not just an elegant addition to any property, Bereco French Doors also incorporate high security espagnolette locking systems and hinge systems which are adjustable in three directions.

The modern interpretation of a French Door is a lipped design where the door leaf is proud of the frame, whilst the classic one is flush. Bereco offer both types in either inward or outward opening configurations with various threshold options.

Engineered timber reduces movement, particularly on larger sized products such as heavy door systems, in addition 68mm thick door leaves further increase the stability of our doors.

Bereco French Doors are available in Contemporary, Traditional and Heritage Ranges and in a wide variety of glass configurations.



Elegant Design. Ultimate Performance.

Image shows Contemporary Range Lipped French Doors with 16mm Georgian bar design. Finish is RAL 9001 Cream. Doors feature single Balmoral handle in polished chrome.



Image shows Traditional Range Lipped French Doors with a 16mm Georgian bar design and curved head. Finish is RAL 9016 Traffic White.

01709 838188



MAIN IMAGE shows Traditional Range Flush French Doors in a bay configuration with 16mm lambs tongue bar design and a combination of frosted and blue coloured glass. Finish is NCS-S-1005-Y20R Parlour.

BOTTOM IMAGE shows double Balmoral Swan handle in brass plated.

French Doors

www.bereco.co.uk



Doors with distinction.

Image shows Traditional Range Lipped French Doors with a 16mm Georgian bar design and curved head. Finish is RAL 9016 Traffic White.

“ For a house to be viewed as successful, window and door architecture is critical. Bereco provide this rare skill and integrity, truly UK’s number one. ”

DAVID EDWARDS

Winner of Daily Telegraph Homebuilding & Renovating Award



French Doors

Image shows Traditional Range Flush French Doors with 25mm triple horizontal bar design. Sliding Sash Spiral Balance Windows with 25mm Georgian bar design. Finish is RAL 9016 Traffic White.

14MM SLIMLINE DOUBLE GLAZING

Retains original aesthetics whilst offering improved thermal performance from that of single glazing.

“ A W Carpentry chose to use Bereco as they could supply Heritage Products with SlimLine double glazing offering the benefits of improved U values whilst aesthetically remaining very close to the original windows, which standard double glazing could not. We had to work within tight parameters set out by Historic Scotland as well as achieving the look and noticeable upgrade in the U value required by the client. Bereco’s Heritage windows set the grounds for the traditional look with help from the technical department customising the detail a little to achieve the original look. ”

TONY WEBB, A W CARPENTRY SERVICES LTD.

Image shows Heritage Range Flush French Doors and Sliding Sash Spiral Balance Windows with a 25mm Georgian bar design. Angled head feature fanlight with sunburst bar. Finish is RAL 9016 Traffic White.

LAUREL HOUSE

Mr & Mrs Curran purchased Laurel House in 2011 with the vision of creating their ideal family home. Although the house already had a good number of bedrooms, they wanted to change the position of the kitchen and expand the ground floor space to suit their needs.

The couple decided to extend the property to create a larger living space and commissioned an architect to design a plan to increase ground floor space by 1,100 sq ft. The extension completely transformed the property and new bespoke windows were needed for the new space.

The couple were working with contractor, CTS, based in Goudhurst, Kent who had worked with Bereco on a number of previous projects. Mr Curran took comfort in the recommendation that Bereco would provide high quality, high performance joinery products.

Products for Laurel House were supplied via Parker Building Supplies.

Image shows Traditional Range Flush Casement Window with faceted bay and curved cill. Finish is RAL 9016 Traffic White. Windows feature silver lead.



Image shows Entrance Door in traditional profile. Finish is dual colour with RAL 9016 Traffic White frame and Farrow & Ball match 26 Downpipe leaf. Traditional Range Flush Casement Windows with curved fanlight. Finish is RAL 9016 Traffic White. Windows feature silver lead.



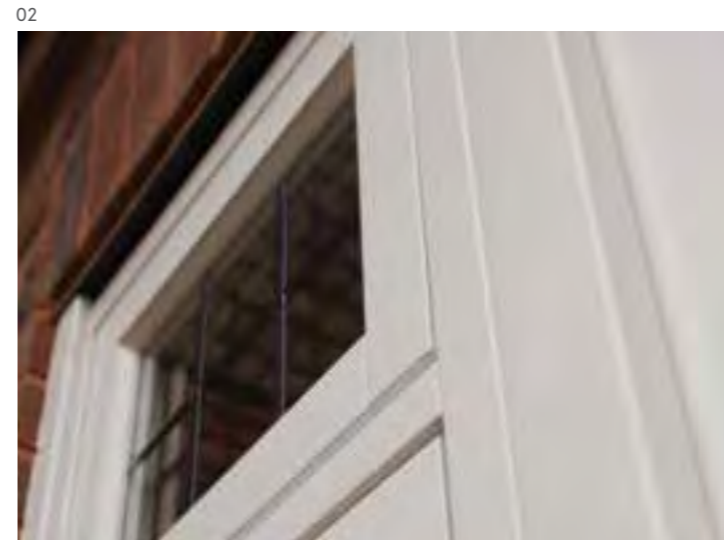

BERECO SUPPLIED BESPOKE ARCHED TOPPED FLUSH CASEMENT WINDOWS, FACETED BAY WINDOWS WITH CURVED CILLS AND ENTRANCE DOORS FROM THE TRADITIONAL RANGE TO PERFECTLY SUIT THE COUPLE'S DESIGN SPECIFICATION.

It was very important that the windows would complement the couple's design vision of creating a Georgian orangery appearance which included a significant amount of stone work and period detailing. The curved design of the building meant it was essential to use a window supplier that could supply made to measure faceted bay windows with matching curved cill detail.

The windows needed to remain in-keeping with the style of the property whilst combining the very latest modern performance features and energy efficiency.

01. Traditional Range Flush French Door and bespoke curved sunburst fanlight with silver lead. Finish is RAL 9016 Traffic White. Hardwood 5064 Walnut stain threshold.
02. Our Flush French Doors are supplied with SFS Easy 3D adjustable hinges for high security and performance, available in brass or stainless steel.
03. Entrance Door in traditional profile with 25mm cottage bar design and Traditional Range Flush Casement Windows with silver lead. Finish is RAL 9016 Traffic White.



Maximise natural light in a traditional building.

Image shows Traditional Range Folding Sliding Door with angled head feature window in Tilt & Turn profile. Fixed Tilt & Turn glazing screen. Finish is RAL 9018 Papyrus White.

FOLD

Folding Sliding Doors are the perfect solution to create a seamless transition between indoor and outdoor space. Design configurations are available with up to 10 leaves, spanning up to 10 metres wide and can open up the entire side of a property.

All Bereco Folding Doors are opening out and are available in both contemporary and traditional profiles.

Contemporary Folding Doors offer the perfect way to create an open plan feel to any room and feature a sleek, modern profile with contemporary pencil round mouldings ideal for a new build home.

Traditional Folding Doors incorporate elegant, ovolo mouldings to complement period design features and offer the ideal solution for introducing maximum light into a traditional style property.

Designed to stack from the left, right or with our unique floating door system (both directions), Bereco Folding Doors are supplied with suited ironmongery.



Folding Sliding Door flush bolts are available in four colours.

1. Polished Chrome
2. Black
3. Brass
4. Satin Chrome

Brio[®]
where ideas unfold

Image shows Contemporary Range Folding Sliding Doors. Finish is RAL 9001 Cream. Door features satin chrome flush drop bolts* and hinges with internal grip handle.

*Please note flush drop bolts vary in size depending on door height.



Create an open plan feel to any room, ideal for entertaining.

Image shows Traditional Range Folding Sliding Doors. Finish is NCS-S 0505-Y20R Parchment.

Folding Doors Configurations

Bereco Folding Doors are available from 2 to 10 leaves in a variety of configurations and are supplied with drop-bolts, hinges and handles.*

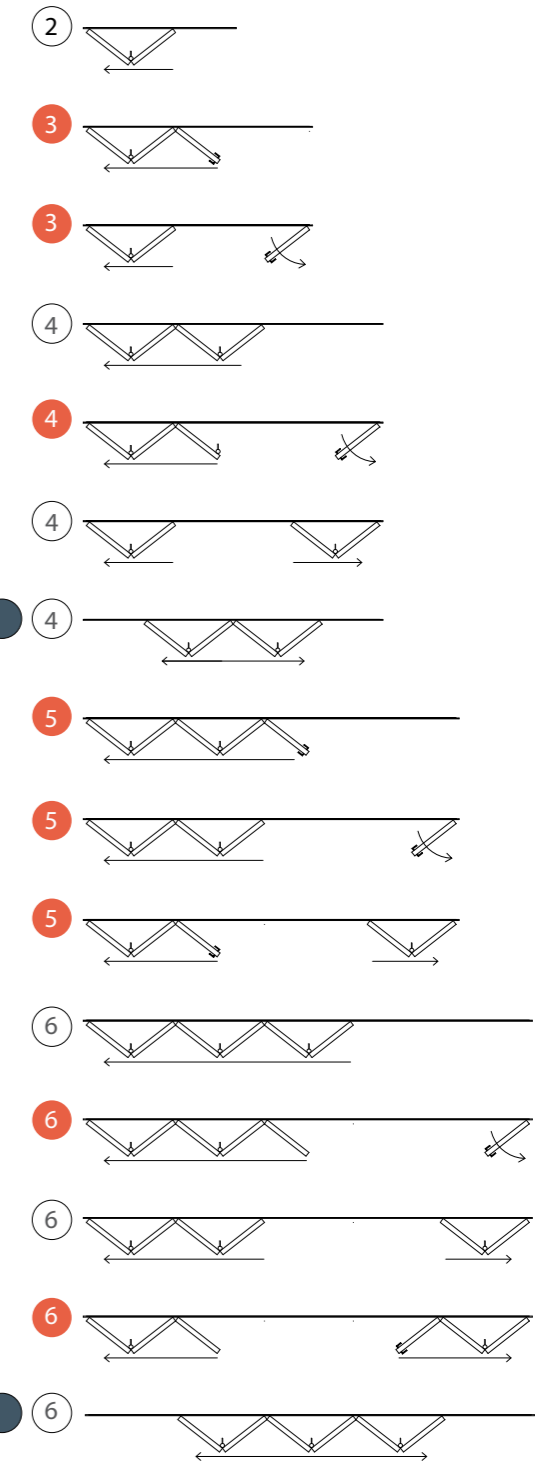

- Internal Grip Handle Only (No External Handle)
- Internal Grip Handle & External Handle
- Floating System

*Designs show opening out and ironmongery is subject to model

THE MOAT HOUSE

The Moat House was built by Allen Dawson's family run timber frame specialist company, Benjamin Allen Bespoke Homes. The Dawsons bought a plot of land in the small picturesque village of Ditchling located at the foot of the South Downs in East Sussex with detailed planning permission for a 300m² house. The Moat House is a stunning Georgian style engineered timber framed home and is Benjamin Allen's flagship design.

Allen took a huge risk and spent a year building this house, which he hoped would advertise his timber frame building skills and help promote and develop his new timber frame family business. Bereco worked in partnership with Parker Building Supplies to supply all the windows and doors for this unique project.

One condition of the planning permission was that the external façade of the building had to be in-keeping with the existing Georgian style architecture in the village. Great care had to be taken when selecting building materials and authentic detailing was essential.

TESTAMENT TO THIS STUNNING BUILD, THE HOUSE WAS FEATURED IN HOMEBUILDING & RENOVATING MAGAZINE.

THE ENTRANCE DOOR FEATURES A GOTHIC BESPOKE BAR DESIGN AND THE HIGH PERFORMANCE SLIDING SASH WINDOWS ALL HAVE GEORGIAN BARS.





Image shows Contemporary Range Sliding Sash Spiral Balance Windows, Lipped French Doors, Folding Sliding Doors and Entrance Door with 16mm Georgian bar design. Finish is RAL 9001 Cream.

The Dawsons have undoubtedly achieved the main objective of this unique project which demonstrates the detail and quality of the workmanship that is evident at The Moat House. Although this project was a big gamble for Allen and his family it is one that has definitely paid off and the family business is now up and running with great success.

The flexibility of Bereco products makes them the perfect choice for unique builds such as The Moat House which required a high level of detailed bespoke joinery work.

When asked about their 'best buy' for the project Allen and Michelle Dawson said "The wooden sash windows are fantastic and came factory finished in our chosen colour which suits the house perfectly."

With their wealth of specialist joinery experience the Dawson family have undertaken much of the project themselves with Allen and his son Ben completing the highly insulated frame in just three weeks.



“ This project is typical of the type of property we would put Bereco products forward for. Our customers often require a variety of joinery styles, product types and bespoke designs all sourced from the same supplier at the same time. The extensive Bereco product range enables Parker Building Supplies to meet customers design needs whilst offering a high quality product with modern performance features. ”

IAN DEAR, JOINERY SPECIALIST AT PARKER BUILDING SUPPLIES

SLIDE

Sliding Patio Doors provide the perfect solution for creating vast open plan areas without encroaching on external space or clashing with internal furnishings. This design offers the ideal solution for creating large glazing areas with minimal timber.

A high security espagnolette locking system and night vent position are incorporated as standard to keep your home fully secure. Configurations are available with a span of up to 10 metres and an innovative lift and glide mechanism make the doors easy to operate.

Contemporary Sliding Patio Doors are well suited to new build properties and feature sleek pencil round mouldings and glazing bars for a stylish, modern look.

Traditional Sliding Patio Doors combine elegant, period ovolo mouldings and glazing bars with a modern method of operation offering the ideal choice for a traditional property.

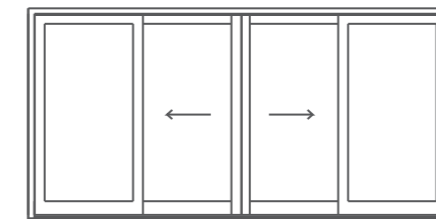

Image shows Contemporary Range Sliding Patio Doors. Finish is RAL 9016 Traffic White.

Maximise your living space with large spanning Patio Doors.

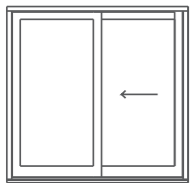

Image shows Contemporary Range Sliding Patio Doors with 16mm double horizontal bar design. Finish is RAL 7003 Moss Grey.



Image shows Traditional Range Sliding Patio Doors. Finish is RAL 9016 Traffic White.



**BULLSEYE WINDOWS
ADD A UNIQUE
DESIGN FEATURE.**
AVAILABLE OPENING OR FIXED.



FEATURE

Feature windows are the ideal way to add a unique design statement to any home. They can be supplied in bespoke sizes and a range of finish options allowing you to be creative.

Our technical team can help you to design products individually tailored to your property.

Image shows Contemporary Range Sliding Sash Spiral Balance Windows and fixed Bullseye feature window with 16mm vertical bar design. Finish is RAL 9016 Traffic White.



LARGE SCREENS

Large screens are the perfect way to maximise glazing areas in stairwells, balconies or to open up the whole façade of a property.

They offer the perfect solution to enjoy the views surrounding a property all year round whilst maximising natural light.



Images show Traditional Range Sliding Sash Cords & Weights Windows, Lipped French Doors and bespoke feature window in matching cords & weights profile with 16mm Georgian bar design. Finish is RAL 9016 Traffic White.

Image shows Traditional Range Flush Casement feature window with 9mm antique black lead. Finish is RAL 9016 Traffic White.

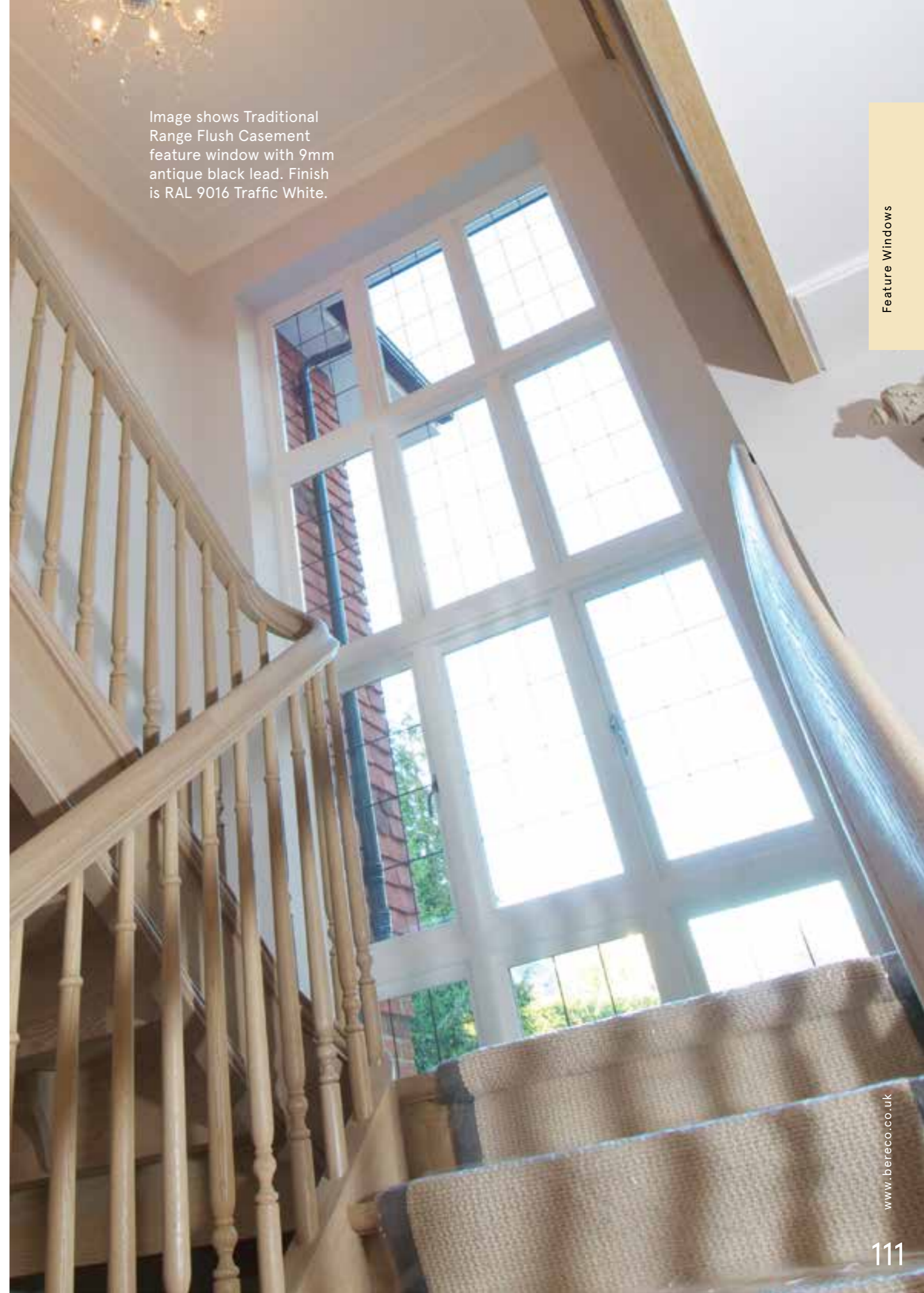

THIS BEAUTIFUL BESPOKE ANGLED HEAD FANLIGHT WITH A SUNBURST BAR ARRANGEMENT & CURVED INTEGRAL SPACER BARS CREATES A PERFECT FOCAL POINT TO COMPLEMENT FRENCH DOORS.

RIGHT IMAGE shows Sliding Sash look-alike with a curved head in a Contemporary Tilt & Turn profile with 60mm solid bar & 16mm bespoke curved bar. Image features plant on horns. Finish is RAL 9016 Traffic White.



SHAPED WINDOWS

Our bespoke products can be supplied opening or fixed with a curved head, arched head, bullseye or ellipse shape for a unique finish.

Bereco products can also be supplied curved on plan. It is not only the frame that is supplied curved but the glazing is also curved for maximum aesthetic appeal.

Curved cills can be supplied on both square and shaped products to complement and match the contours of any building.

BESPOKE FANLIGHTS & SIDELIGHTS

A unique feature can be added to any door or window with bespoke fanlights and sidelights designed according to individual customer specification.

ANGLED HEAD

Create an individual finish with an angled head feature window screen, ideal for a gable end or sun room.

Image shows Heritage Range angled head fanlight with 25mm sunburst bar arrangement.

MOULDINGS & BARS

Our exclusive mouldings and bars bring unique character to our Contemporary, Traditional and Heritage Ranges. Frames, sash profiles and bars have been carefully designed with the style of your property in mind.

Contemporary Range products feature pencil round mouldings with contemporary bar designs in 16mm, 25mm, 35mm or a 60mm solid bar.

The Traditional Range features period style internal ovolo mouldings and an external putty style design with the option of a 16mm lambs tongue bar, 25mm or 35mm ovolo bar or a 48mm solid ovolo bar.

Heritage Range products are designed with authentic lambs tongue mouldings and an external putty style design with glazing bars available in 16mm, 25mm, 35mm or a 48mm solid bar.

Bars are supplied in a wide range of bespoke designs including gothic, sunburst and curved bar arrangements.

ALL Bereco PRODUCTS ARE INTERNALLY GLAZED AS STANDARD.

Image shows Heritage Range Flush French Doors with 25mm Georgian bar design. Doors feature 14mm SlimLine double glazing and raised & fielded panels. Finish is RAL 9016 Traffic White.

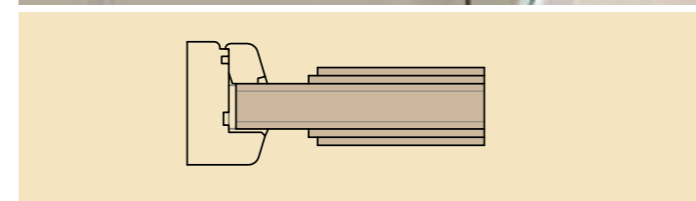

Contemporary Panels

Multi layered insulated panel designs are used to create a raised and fielded detail on Contemporary Range Doors for a modern appearance.

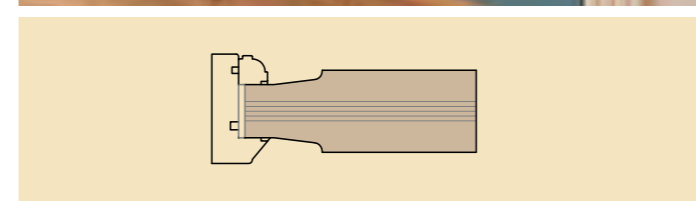

Traditional & Heritage Panels

Sculpted insulated panels are consistent across both the Traditional and Heritage Ranges to create the look of authentic timber door designs.

Contemporary Mouldings

Internal & external pencil round mouldings are a consistent design feature on all products across the Contemporary Range.



Contemporary Internal



Contemporary External

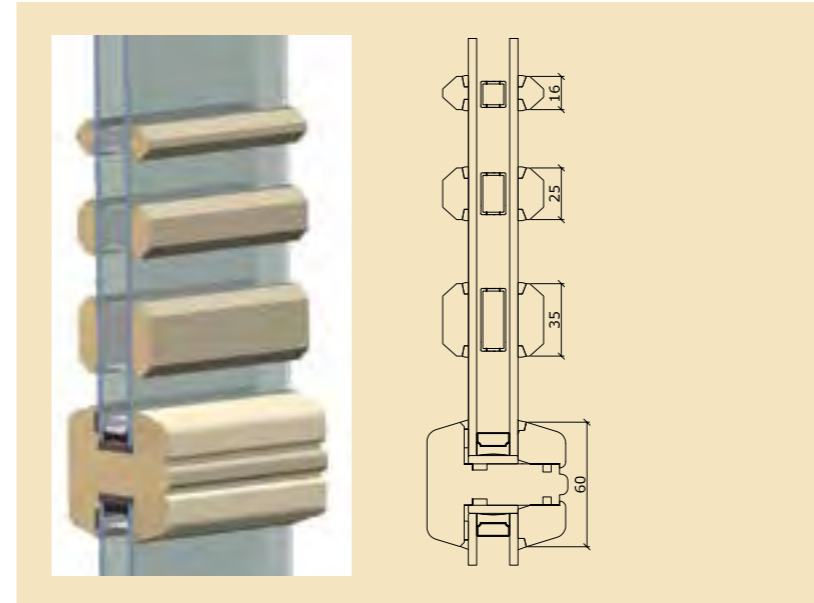

Contemporary Bars

The Contemporary Range features pencil round bar designs specifically designed to suit the aesthetics of new build properties. Sizes are available in 16mm, 25mm and 35mm stick on and a 60mm solid bar.

Traditional Mouldings

Internal ovolo mouldings and external putty style design features are consistent throughout the Traditional Range to further enhance the character of any property.



Traditional Internal



Traditional & Heritage External

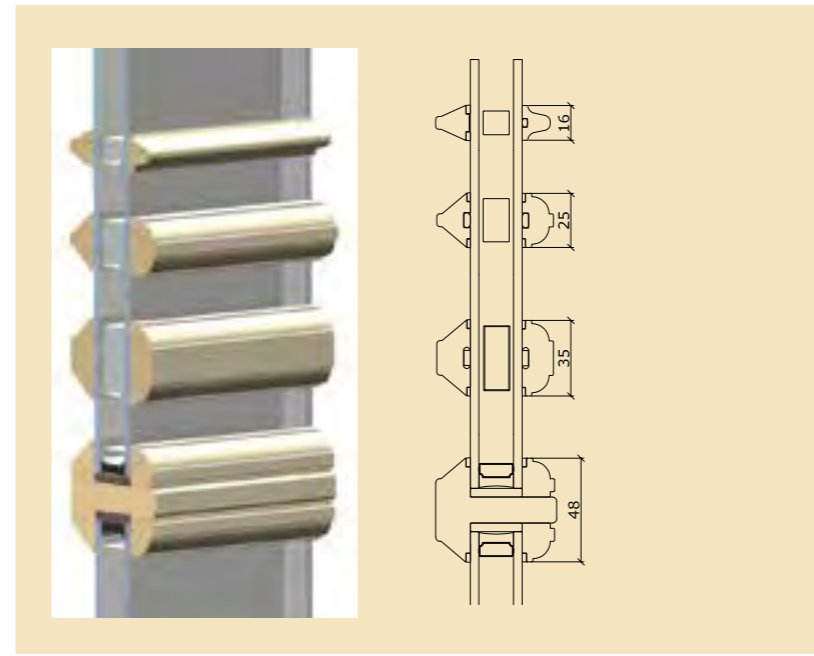

Traditional Bars

The Traditional Range features a selection of lambs tongue or ovolo profile glazing bars available in a range of sizes to suit your design needs. Sizes are available in 16mm lambs tongue, 25mm, 35mm stick on and a 48mm solid bar.

Heritage Mouldings

Heritage designs incorporate period aesthetics utilising internal lambs tongue profile glazing beads and external putty style design to mirror the distinctive features of original timber windows.



Heritage SlimLine Internal

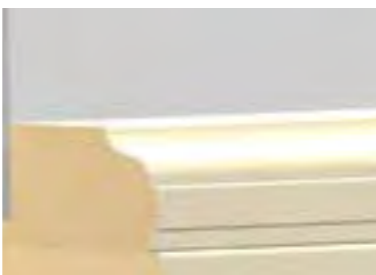

Heritage Single Internal

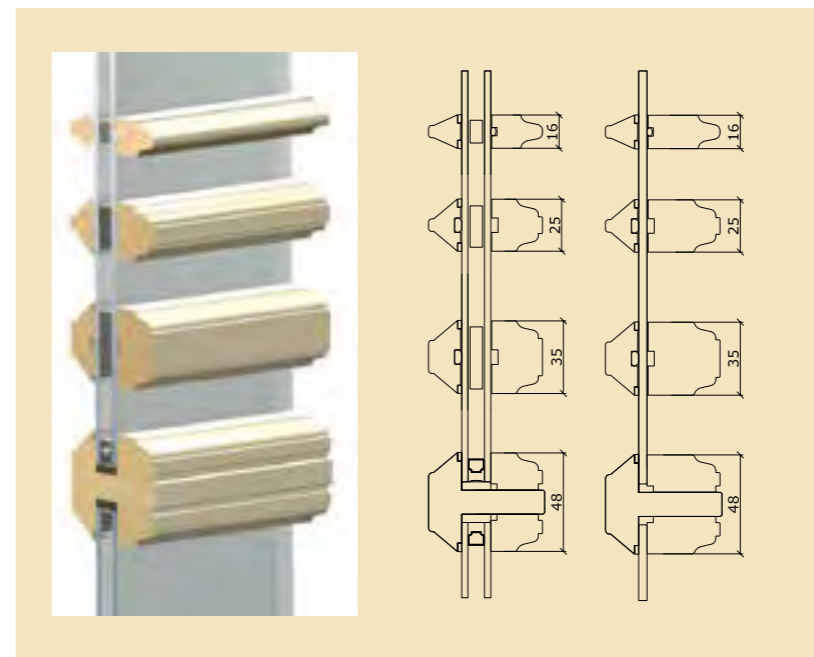

Heritage Bars

The Heritage Range features lambs tongue profile glazing bars available in a range of sizes to suit your design needs. Sizes are available in 16mm, 25mm, 35mm stick on and a 48mm solid bar.

Contemporary Range and Traditional Range glazing bar designs are representative of double and triple glazing. Heritage Range glazing bar designs are representative of single and SlimLine glazing.

THE MEETING HOUSE

The Meeting House is located near the Pantiles, a Georgian colonnade, in the picturesque conservation town of Royal Tunbridge Wells in Kent. Originally built as a chapel in the 18th century, the historic building has since been converted into luxury office space.

Lesters Building Contractors were chosen to replace the original windows and doors due to their significant experience of working on complex conservation projects.

Bereco were able to supply bespoke floor to ceiling feature windows with arched head detail and black painted glazing to replicate the original design. The bespoke nature of Bereco products meant the windows could be individually designed to accommodate varying opening sizes.

Lesters Building Contractors have worked with Bereco for over 10 years and continue to be impressed with the versatility and quality that the product range can offer. Due to the complexity and architectural sensitivity of this project, Glenn Lester had no hesitation in choosing Bereco to supply windows and doors from the Traditional Range.

It was essential that the replacement timber windows and doors remained sympathetic with the historic structure of the building and were in-keeping with the surrounding conservation area.

The windows had to be of a traditional appearance to replicate the existing feature windows whilst offering 21st century, high performance features to improve energy efficiency and reduce heat loss.



Image shows Traditional Range Flush Casement Windows with bespoke curved head. Finish is RAL 9016 Traffic White. Windows feature black painted glass RAL 9005 Jet Black.

Double leaf Entrance Doors in traditional profile. Finish is dual colour with RAL 9016 Traffic White Frame and RAL 9005 Jet Black leaf.



Image shows Traditional Range Flush Casement with bespoke curved head. Finish is RAL 9016 Traffic White. Windows feature black painted glass RAL 9005 Jet Black.

“ We have worked with Bereco for over 10 years and have continued to be impressed by the quality of the products and level of service we continue to receive. We worked with Ian Dear, a joinery specialist at Parker Building Supplies, to help us to achieve the required specification.

Nothing seems to beat Bereco, from the arched topped Flush Casement Windows in The Meeting House to the 7 metre wide Folding Sliding Doors we have used in other projects. We go to Bereco with challenging projects and they are able to find the solutions to meet our fenestration needs. ”

Glenn Lester

Lesters Building Contractors

THE BLACK GLAZING PANES ARE DESIGNED TO CONCEAL THE FLOOR JOISTS OF THIS PERIOD BUILDING WHILST ADDING A UNIQUE TWIST TO THE WINDOW DESIGN.

TIMBER & FINISH

All Bereco products can be supplied in softwood or hardwood. The 4-stage finishing process of preservation, basecoat and two top coats give softwood products a smooth finish and hardwood a pitted effect due to its open pore structure.

Engineered or multi-layered timber is used throughout our ranges and products. Opposing grain direction, combined with removal of the natural defects inherent in timber such as knots and shakes help add significant strength to product sections. Safe in the knowledge no defects are located around critical locations, engineered timber is also key to reducing the effects of warp and twist ensuring longevity and performance.

Our high quality product finishes are certified by the BM TRADA Q-Mark Paint Application Scheme. This ensures paint coatings are applied in the correct environment, using the latest manufacturing techniques and machinery by personnel that are trained to the highest standards to ensure product longevity.

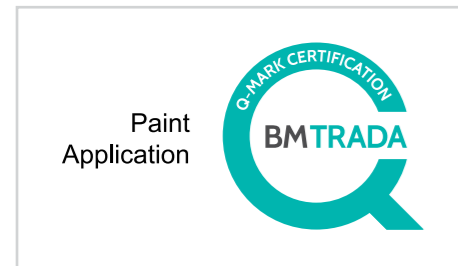

TOP IMAGE shows Traditional Range Flush Casement and Flush French Doors with 25mm bars to top sash. Entrance Door in traditional profile with sidelights. Finish is RAL 7012 Basalt Grey.

BOTTOM LEFT IMAGE shows Traditional Range Sliding Sash Spiral Balance Windows. Finish is RAL 6019 Pastel Green.

Entrance Door in traditional profile. Finish is dual colour with RAL 6019 Pastel Green frame and RAL 6029 Mint Green leaf.

BOTTOM RIGHT IMAGE shows Contemporary Range Sliding Sash Spiral Balance Windows. Finish is RAL 9016 Traffic White.

Cheeks are ideal for properties with tile hanging or cladding.



ALL Bereco products ARE FULLY FACTORY FINISHED AS STANDARD.

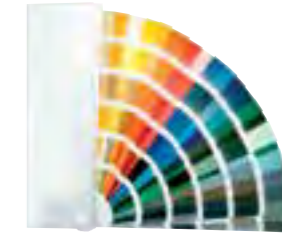

PAINT IT.*

Introduce a splash of colour with your choice of any RAL, BS and NCS colour.

STAIN IT.*

Our range of 16 translucent stains add colour whilst allowing the natural character, grain and beauty of the timber to show through.

MATCH IT.

We can replicate any colour from the Farrow & Ball range.

FRAME IT.

A contrasting door frame & leaf or window sash & frame finish creates a design statement.



DUAL COLOUR.

Dual paint and stain options are available on both finishes to suit internal décor and external façade.

* Coloured swatch samples are available on request.



GLAZING

The types and specification of glass can have a dramatic effect on the performance of windows and doors, home comfort and heating costs.

The commonly referred to U values give an indication of heat loss; the lower the value, the better the insulation.

The Uw value is the overall U value of the window (frame & glass)

The Ug value is known as a centre pane value (glass only)

Softcoat Low-E glass, warm edge spacers and glazing units are filled with inert gases Argon or Krypton to dramatically reduce U values on Bereco products.

All double and triple glazed units utilise Softcoat Low-E coatings as standard. This special reflective coating restricts heat exchange between the panes of glass keeping the inner pane warmer.

Insulating warm edge spacer bars around the perimeter glazing eliminate internal condensation caused by the cooling thermal bridge effect. White, black, grey and brown colours are available to complement the product finish.

DOUBLE GLAZING

Available with Argon filled units only, designs offer a centre pane Ug values as low as 1.0 W/m²K and overall Uw values of 1.2 W/m²K.

TRIPLE GLAZING

Our triple glazed products are available with either an Argon or Krypton filled unit. Excellent centre pane Ug values as low as 0.5 W/m²K and overall Uw values of 0.8 W/m²K can be achieved with Krypton.



FOR ENHANCED SECURITY ALL OF OUR WINDOWS ARE INTERNALLY GLAZED AS STANDARD

Image shows Traditional Range Flush Casement Windows with 25mm cottage bar design. Finish is RAL 9016 Traffic White. Windows feature polished chrome ironmongery.

14MM SLIMLINE DOUBLE GLAZING

14mm SlimLine double glazing offers the aesthetic appearance of single glazing whilst offering improved thermal performance. Krypton filled units with warm edge spacers are supplied as standard. Designs are available with centre pane Ug values of 1.2 W/m²K and overall Uw values of 1.3 W/m²K.

4MM SINGLE GLAZING*

All Heritage Range products can be supplied with 4mm single glazed units, ideal for the most architecturally sensitive projects. Designs are available with centre pane Ug values of 5.8 W/m²K and overall Uw values of 4.5 W/m²K.

ACOUSTIC GLAZING

For many homeowners across the UK, high levels of external noise are of concern. Not only does it cause discomfort in the home but more importantly, recent studies have highlighted a strong link between prolonged exposure to high levels of noise and serious health issues.

Acoustic glazing is available across both our Contemporary and Traditional Ranges and can be used to achieve decibel ratings up to 45dB.

SPECIALIST GLAZING

PAINTED GLASS

Add a unique twist and a modern alternative to obscure glazing with a totally opaque finish in a RAL colour of your choice. Ideal for use in screens where floor joists need to be hidden.

COLOURED GLASS

Coloured glass offers a modern interpretation of stained glass. A wide range of colour options can be chosen to accentuate your design.

ANTI SUN GLASS

Anti sun glass is ideal for large glazing areas as it reduces the amount of heat from the sun (solar energy transmittance g value) transmitted through glass, helping create a comfortable room temperature all year round. Available in 4 colour options: blue, green, bronze and grey.

SELF CLEANING GLASS

Self cleaning glass helps keep your windows cleaner for longer, saving both time and money.

MAKE A STATEMENT WITH LEADED GLASS OR ADD A UNIQUE TWIST WITH COLOURED GLASS.



01.



02.



03.



04.



05.

LEADED GLAZING

We can replicate traditional or create completely bespoke lead patterns.

Choose from antique black, silver, gold and old gold coloured lead available in 6mm and 9mm.

BEVELLED GLASS

Bevelled glass is the ideal focal point that can make all the difference to a feature window or door.

The edge of the glass is chamfered at an angle creating an elegant framed look whilst reflecting light to produce a beautiful array of colours.

Please note painted, coloured, anti sun, self cleaning and bevelled glass is not available in obscure glass.

- 01. Image shows painted glass in RAL 9005 Jet Black.
- 02. Image shows coloured glass in light yellow.
- 03. Image shows Anti Sun glass in blue.
- 04. Image shows Traditional Range Lipped Casement with 6mm antique black lead. Finish is RAL 9016 Traffic White.
- 05. Image shows Contemporary Range Lipped French Doors with 9mm antique black lead. Finish is RAL 9016 Traffic White.

OBSCURE GLAZING

Obscure glazing is the ideal way to increase privacy in the home, conceal unwanted views or to simply add a distinctive design feature to a window and door. A variety of obscure glazing patterns are available with different designs offering varying privacy levels (rated 1-5 with 5 being the highest obscurity level)

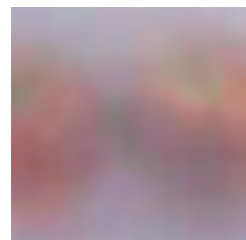

Frosted 5



Stippolyte 4



Kocie 4



Chinchilla 3

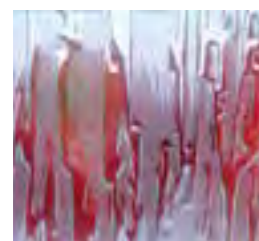

Niagara* 5



Cotswold 5



Kora 4



Delta 5

Customise window and door designs with frosted glass for house numbers, letters or borders.



FROSTED GLASS FOR INCREASED PRIVACY

Image shows Contemporary Range Sliding Sash Spiral Balance Windows with 16mm Georgian bar design and frosted glazing. Window features a vent lock. Finish is RAL 9001 Cream.

*Niagara is only available in float glass.

FINISHING TOUCHES

We offer a wide range of finishing touches, designed to save time during installation or to further enhance the appearance of the windows and doors. All products are supplied factory finished ensuring a consistent, quality finish. Window boards and architraves can also be supplied to match the finish of the product.

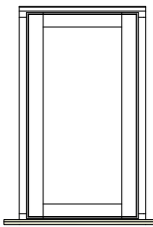

Cill Horn.

Extends either side of the window frame.

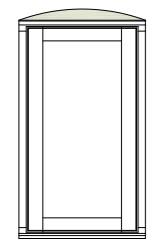

Arched Packer.

Where infills are required to an arched lintel to create a curved head.

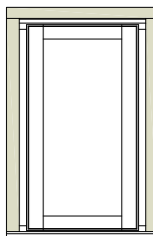

Packer.

For use where a reveal is present or where render returns onto the window.

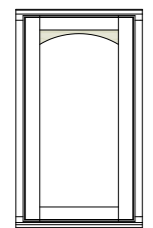

Curved Plate.

The sash and glass is supplied as one complete curved unit to create a unique design feature.

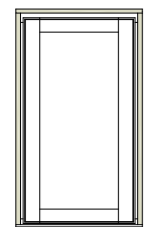

Cheeks.

Ideal for dormer windows or where tile hanging is a feature.

Image shows Contemporary Range Sliding Sash Cords & Weights Windows with 16mm Georgian bar design and arched head packers. Contemporary Range Lipped French Doors. Finish is BS.10.B.15 Gardenia.

Arched packers for a curved head effect



Cheeks to suit a tile hanging façade.

Image shows Traditional Range Flush Casement Window with 9mm antique black lead and cheeks. Finish is RAL 9016 Traffic White.



Customise your window design with fluted posts & facings.

Image shows Traditional Range Sliding Sash Spiral Balance Windows with chamfered and fluted posts. Finish is RAL 9016 Traffic White.



Image shows Contemporary Range Lipped Casement Window with fluted corner post. Finish is BS.10.C.31 Buttermilk.



39dB
Acoustic glazing was used due to the city centre location.

A curved plate feature to the top sash.

Image shows Traditional Range Sliding Sash Spiral Balance Windows with curved outside head facing and curved plate. Finish is RAL 9016 Traffic White.

SPECIFYING BERECO

RESOURCE CENTRE

The appropriate and detailed specification of windows and doors is an important consideration for any project.

The Bereco Resource Centre is designed to provide easy access to product information on the complete Bereco product range at the click of a button.

CAD drawings displaying individual product section sizes are available to view and download in DWG, DXF and PDF format.

Sign up to the Resource Centre today at www.bereco.co.uk



FASTRACK CAD

Bereco's CAD drawings are available on the architectural CAD database, FastrackCAD in DWG or PDF format.

Visit our profile now at www.fastrackcad.com



RIBA NBS PLUS

Bereco are featured in the NBS Plus library of product clauses offered in NBS specification products. Each product clause is authored in NBS format making its inclusion in project specifications quick and easy.



RIBA PRODUCTSELECTOR.COM

The downloads section is home to our NBS style technical specification sheets. This contains all the relevant literature to enable you to find out more details about Bereco and our product range.

www.ribaproductselector.com

Image shows Traditional Range Flush French Doors with sidelights and a 25mm Georgian bar design. Finish is RAL 9016 Traffic White.



Image shows Traditional Range Flush Casement Windows with 16mm horizontal bar design. Finish is NCS-S-3010-G80Y French Green.

SUSTAINABILITY & ENVIRONMENT

We are committed to environmentally friendly practices that are reflected throughout the manufacturing process. Using the most environmentally friendly, sustainable material our timber windows and doors achieve the highest possible FSC classification. Additionally, designs incorporate the latest high performance features to save energy.

FSC® CERTIFICATION.

All products from across the entire Bereco range are manufactured using FSC® certified timber, responsibly sourced from sustainable, well managed forests.



The mark of responsible forestry

THE BRITISH WOODWORKING FEDERATION & THE WOOD WINDOW ALLIANCE.

Bereco is a member of the British Woodworking Federation and The Wood Window Alliance (WWA). As a member of the WWA Bereco products are required to meet independently verified quality, performance and sustainability criteria.



CODE FOR SUSTAINABLE HOMES.

All products are A+ rated as part of the BRE Green Guide which helps towards achieving the Code for Sustainable Homes.

PASSIVHAUS.

Our triple glazed windows offer Uw values as low as 0.8 W/m²K enabling projects to be developed to Passivhaus standards.

CERTIFICATION & WARRANTIES

Bereco products are fully compliant with the latest building regulations and are certified to the latest PAS 24:2012 standards. Our high performance products are designed with the latest security features offering customers peace of mind that their home is safe and secure.

WARRANTIES*

As a member of the Q-Mark High Performance Window Scheme we are able to offer extensive, credible warranties attached to all our products.

- 10 YEARS FACTORY COATINGS
- 10 YEARS MANUFACTURING DEFECTS
- 10 YEARS GLAZING UNITS
- 10 YEARS IRONMONGERY
- 30 YEARS ROT & FUNGAL DECAY

MAINTENANCE PRODUCTS

Our special clean and care system will restore shine to windows and doors whilst improving performance and maintaining all important warranties.



*Warranties must be registered at www.berecowarranties.co.uk and are subject to terms and conditions. Factory coatings are subject to following the approved Bereco maintenance schedule.

ADVICE & GUIDANCE ON WINDOW & DOOR SPECIFICATION.

Our experienced, dedicated technical team are at hand to discuss individual project requirements in detail.

INDEPENDENT ACCREDITATIONS

Our quality assurance schemes offer peace of mind that all products are subjected to rigorous testing.

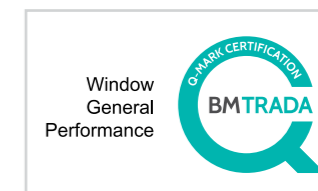
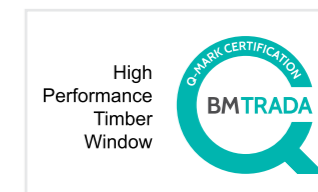

Image shows Contemporary Range Lipped Casement Windows, Lipped French Doors and Folding Doors. Finish is RAL 9016 Traffic White.

PRODUCT SELECTION

Product Type	Contemporary Range	Traditional Range	Heritage Range
Sliding Sash Spiral Balance Windows	Yes	Yes	Yes
Sliding Sash Cords & Weights Windows	Yes	Yes	Yes
Lipped Casement Windows	Yes	Yes	No
Flush Casement Windows	No	Yes	Yes
Tilt & Turn Windows	Yes	Yes	No
Entrance Doors	Yes	Yes	No
Creative Entrance Doors	Yes	No	No
Lipped French Doors	Yes	Yes	No
Flush French Doors	No	Yes	Yes
Folding Sliding Doors	Yes	Yes	No
Sliding Patio Doors	Yes	Yes	No

Feature	Contemporary Range	Traditional Range	Heritage Range
Internal ovolo mouldings	No	Yes	No
Internal & external pencil round mouldings	Yes	No	No
Internal lambs tongue mouldings	No	No	Yes
External putty bead design	No	Yes	Yes
Casement stays *	No	Yes	Yes
Decorative dummy butt hinges on Flush Casements *	No	Yes	Yes
Night vent *	No	Yes	Yes
Trickle ventilation	Yes	Yes	Yes
16mm Pencil round bar with back to back unit spacer	Yes	No	No
16mm Lambs tongue bar with back to back unit spacer	No	Yes	Yes
25mm Pencil round bar with back to back unit spacer	Yes	No	No
25mm Ovolo bar with back to back unit spacer	No	Yes	No
25mm Lambs tongue bar with back to back unit spacer	No	No	Yes
35mm Pencil round bar with back to back unit spacer	Yes	No	No
35mm Ovolo bar with back to back unit spacer	No	Yes	No
35mm Lambs tongue bar with back to back unit spacer	No	No	Yes
48mm Ovolo solid bar	No	Yes	No
48mm Lambs tongue solid bar	No	No	Yes
60mm Pencil round solid bar	Yes	No	No
6mm Lead (antique black/silver/gold/old gold)	Yes	Yes	Yes
9mm Lead (antique black/silver/gold/old gold)	Yes	Yes	Yes

Glazing	Contemporary Range	Traditional Range	Heritage Range
24mm Double glazing	Yes	Yes	No
Triple glazing	Yes	Yes	No
Acoustic glazing	Yes	Yes	No
4mm Single glazing	No	No	Yes
14mm SlimLine double glazing	No	No	Yes
BFRC A Rated	Yes	Yes	No
Bevelled glass	Yes	Yes	No
Painted glass	Yes	Yes	No
Coloured glass	Yes	Yes	No
Anti sun glass	Yes	Yes	No
Self-cleaning glass	Yes	Yes	No

* Only available on Casement Windows



01



02



03



04



05



06

- Image shows Traditional Range Lipped French Doors with arched head and 16mm curved bar. Lipped Casement Windows with 16mm horizontal bar design. Finish is RAL 9016 Traffic White.
- Image shows Traditional Range Flush Casement Windows and Flush French Doors with a mixture of 16mm Georgian and cottage bar designs. Finish is 9016 Traffic White.
- Image shows Traditional Range Flush Casement Windows with a mixture of 25mm Georgian and cottage bar designs. Finish is dual colour with RAL 9005 Jet Black frame and RAL 9016 Traffic White sash.
- Image shows Traditional Range Sliding Sash Spiral Balance Windows with 25mm vertical bar design. Finish is RAL 9016 Traffic White.
- Image shows Creative Range Entrance Door with sidelights. Finish is dual colour with RAL 7016 Anthracite Grey frame and RAL 6034 Pastel Turquoise leaf.
- Image Shows Entrance Door in traditional profile and Traditional Range Lipped French Door with sidelights and 16mm Georgian bar design.



“ We have been working with Bereco for a number of years and would not recommend them to our clients unless we had absolute faith that they would look after them and we have never been let down. Their sales team are very knowledgeable about their product and the technical team work hard to fulfill our exact requirements. They are all a pleasure to deal with and the product is very well made and competitively priced. ”

Alexandra Hull

Managing Director

Back to Front Exterior Design

Image shows Traditional Flush Casement Windows with 25mm cottage bar design. Entrance Door in traditional profile with sidelights. Finish is RAL 9016 Traffic White.

IN A RECENT CUSTOMER SURVEY WE FOUND THAT

100

100% of customers said they would order from Bereco again.

100

100% rated the quality of Bereco products as excellent or very good.

92

92% would recommend Bereco due to the level of customer service.

CONTACT US



We cover all mainland UK locations with no minimum order quantity.

Off loading facilities are available on all UK mainland deliveries, products are delivered to site, securely palletised and fully wrapped for protection. All products are referenced by window number for ease of identification during fitting.

BERECO SHOWROOM
South Yorkshire

Opening Hours
Monday - Friday
8am - 5pm

Please contact a member of the Bereco team to arrange a viewing.

BERECO TRADE (New Build)

South Yorkshire
Bereco Limited
Unit 5 Aspen Court
Centurion Business Park
Bessemer Way
Rotherham
S60 1FB

t: 01709 838188
f: 01709 838330

enquiries@bereco.co.uk

Northumberland
Bereco Limited
Suite 1, 17A Windmill Way West
Ramparts Business Park
Berwick upon Tweed
Northumberland
TD15 1TB

t: 01289 306208
f: 01289 306188

enquiries@bereco.co.uk

BERECO RETAIL (Replacement)

South Yorkshire
Bereco Retail Limited
Unit 4 Aspen Court
Centurion Business Park
Bessemer Way
Rotherham
S60 1FB

t: 01709 377406
f: 01709 379586

enquiries@berecoretail.co.uk

TIMBER
ECO
PERFORMANCE
SECURE
CHOICE
BESPOKE

WWW.BERECO.CO.UK